



## BRIEF INFORMATION

### DuraLED surface mount courtesy lamp

- › Lens made from high impact resistant acrylic
- › Ultra long service life
- › Slim design – thickness of 9 mm

## PRODUCT FEATURES

HELLA, the world's premier automotive lighting specialist, has upgraded the range of easy-mount DuraLED courtesy lamps, with a dual coloured lens featuring a white surround and a high impact resistant acrylic optical section. This lamp series includes a robust Multivolt circuit with very low power consumption.

Lightweight and easy to install, DuraLED surface mount courtesy lamps are UV, chemical, stress and impact resistant. Optional accessories include a marine grade – 316 stainless steel rim and mounting seals.

## FURTHER PRODUCT FEATURES

### Reverse polarity protection

If the polarity is accidentally reversed, the light does not suffer any damage.

### Sealed to withstand high-pressure cleaning

Tested to IP 6K7 and IP 6K9K, this light is protected from dust and water ingress under constant immersion.

### High vibration resistance

The lights have been tested to HELLA Norm 67101 and meet the requirements for OEM production buses, commercial vehicles and tractors over 6.5 t.

### Designed for a Fit and Forget service life

The latest LED technology provides an optimum signal pattern with low power consumption.

## LED LIGHTING TECHNOLOGY

As a leading innovator in the field of automotive original equipment, HELLA is setting benchmarks:

### Extremely low energy consumption

With the combination of efficient light-emitting diodes (LEDs) and precision optics, HELLA lights achieve the statutory light distribution with over 90 % less power consumption compared to bulb lamps! No change of light source, no maintenance and an extremely long operating life due to optimal thermal management.

To extend the design life of the light, the components are arranged in a way that optimises the temperature conditions, preventing overheating of the LEDs at high ambient temperatures. Competent thermal management maximises design life. The design life of these LED lamps corresponds to that of the vehicle.



# TECHNICAL DETAILS

## Technical Data

Operating voltage	Multivolt
Power consumption	0.5 W
Mounting	Horizontal or vertical
Number of LEDs	2
Operating temperature	-40 °C bis +60 °C
Protection class	IP 6K7, IP 6K9K
Contacts	0.5 m cable
Installation	Screw connection with 2 screws Ø 5 mm
Specification	Norm 67101, class 1.3, 2.3, 3.3, 4.2, 5.2, 6.2, 7.3, 10.3, 11.3
Design life	Design life of the vehicle*

\* Dependent upon the operating temperature.

## Technical drawing

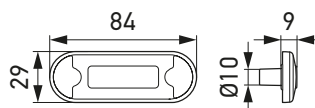

### With optional stainless steel rim

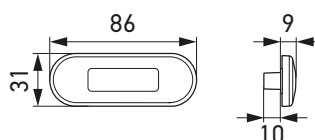

### Hole pattern

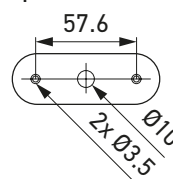



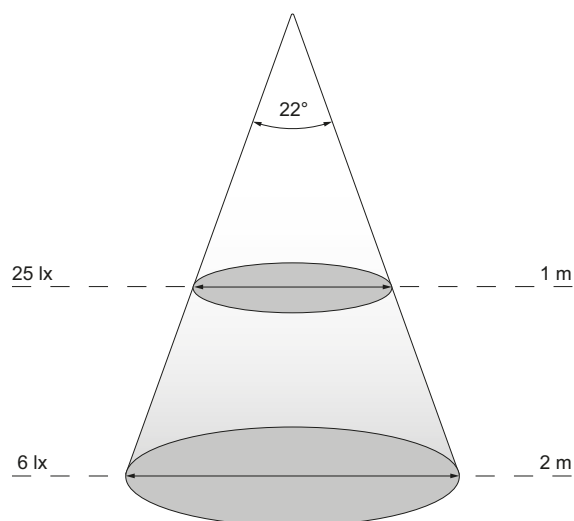
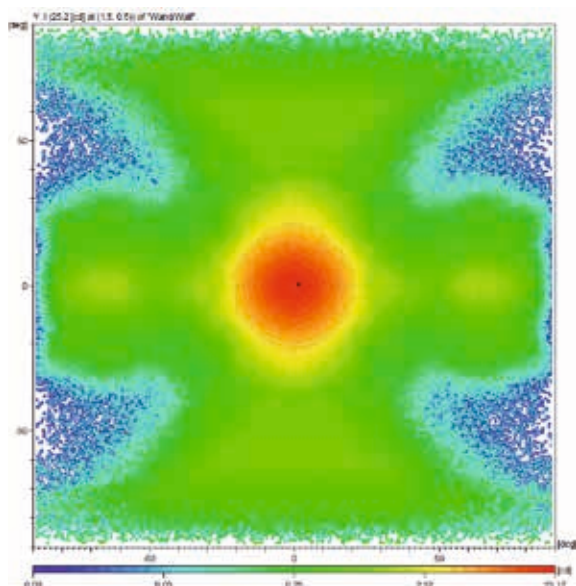

# LIGHT DISTRIBUTION









Courtesy lamp, white  
2XT 980 855-117

## RANGE OVERVIEW

Product Image	Function	Part Number	PU*
	Courtesy lamp, white	2XT 980 855-111	1
	Courtesy lamp, amber	2XT 980 855-117	16
	Courtesy lamp, red	2XT 980 855-267	16
	Courtesy lamp, blue	2XT 980 855-347	16
	Courtesy lamp, green	2XT 980 855-401	1
		2XT 980 855-517	16

\* Packaging Unit

## SPARE PARTS / ACCESSORIES

Product Image	Function	Part Number	PU*
	Polished stainless steel rim	9AB 959 685-001	1
	Satin chrome plated stainless steel rim	9AB 959 685-061	1
	Screw caps, black	9HD 980 858-008	4
	Screw caps, white	9HD 980 858-018	4
	Seal curved 1x2 flush mount	9GD 958 028-001	1
	Seal rectangular 1x2 flush mount	9GD 980 867-507	8

\* Packaging Unit